



MoveMic

The Shure MoveMic

Online user guide for the Shure MoveMic Kit. Pair the MoveMic clippy to your device or the receiver. Shoot landscape or portrait video. Stream to Facebook or YouTube. Adjust EQ, compression, update firmware, find supported devices, and troubleshoot.

Version: 1.5 (2024-D)

Table of Contents

MoveMic The Shure MoveMic	3	Adjusting the Receiver	17
Quick Start Guide	3	Connecting to the Receiver	18
Wearing the Mic	3	Pairing to the Receiver	19
MoveMic Best Practices	3	The Receiver Display	19
General Description	3	The Receiver Menu Tree	20
Features	4	Recording Tips	21
The Shure MoveMic	4	Turn On Airplane Mode and Do Not Disturb	21
Powering the MoveMic On and Off	4	Capture Clear Sound	21
The MoveMic Charge Case	6	Use the Dark Theme	21
Charge Case Status LED Indicators	6	Monitor Your Sound	21
Important Tips for Care and Storage of Shure Rechargeable Batteries	7	Gallery	21
The MOTIV Audio Application	7	Video Playback	22
Pairing to the MOTIV app	7	Sharing Video Recordings	24
Mic Settings	8	MoveMic Firmware Updates	24
The MOTIV Video Application	11	Troubleshooting	25
Features	11	System Requirements	26
Video Standby Mode	12	System Requirements and Compatibility: iOS	26
Video Record Mode	13	System Requirements and Compatibility: Android	26
Live Streaming	14	Accessories	26
Live Stream Using the MOTIV Video App	14	Furnished Accessories	26
Easy Live Streaming to Facebook and More	15	Optional Accessories	27
Stream to Facebook	15	Specifications	27
Stream to YouTube	15	The MoveMic	27
While You Stream	15	The MoveMic Charge Case	29
Hardware Receiver	15	The MoveMic Receiver	29
The MoveMic Receiver	15	Open Source Attribution	31
MoveMic Receiver LED Indicators	16	Certifications	31

MoveMic

The Shure MoveMic

Quick Start Guide

1. **Charge:** Make sure that battery is fully charged before first use.
2. **Download the Application:** Follow steps for installation using the App Store or Google Play. The first time you use the MOTIV application you will be prompted to allow access to the device camera and microphone. You can grant Location Services permission and share usage analytics with Shure.
3. **Pair:** Remove charged MoveMics from the charge case; power on and pair to the MOTIV application.
4. **Record:** You are ready to start recording.

Note: We recommend that you use a wired connection to monitor your recordings. First plug-in your wired headphones and then pair the MoveMics to the app when using a mobile device. Plug directly into the receiver when using the hardware receiver. Monitoring your recording while using a Bluetooth headset is not recommended.

Wearing the Mic

Wear the MoveMic with the clip facing out and the MoveMic body discretely hidden behind clothing to minimize camera visibility.

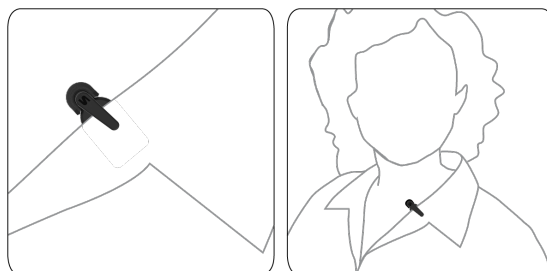

MoveMic Best Practices

When recording with the MoveMic kit, use the following best practices:

- Always remain in line of sight from the MoveMic to your receiver; either the MV-R or your phone if utilizing the MOTIV app.
- Minimize distance for optimal video content and wireless performance. Many creators stay within 20ft (6m) to have the best visibility and strongest sound.
- Position the MoveMic so the body of the transmitter is placed behind clothing to minimize visibility on camera.
- When using with a mobile phone we recommend putting your device into airplane mode and Do Not Disturb to prevent interruptions to the recording caused by phone calls, texts or alerts.
- Only use wireless to connect to the MoveMic products. For optimal performance don't use other wireless devices at the same time, like wireless earphones or speakers, smart watches, gimbals or other devices.

General Description

The Shure® MoveMic Wireless Lavalier Microphone System provides instant video livestreaming or audio and video recording with high fidelity audio to your mobile device. The kit includes 2 discrete MoveMic lavalier microphones that use the MOTIV Audio or Video Recording application to adjust mic settings and record or stream to the web. The system is ideal for recording situations that require vocal clarity with a balanced tone and discrete form that works on the go.

Features

- Compatible with iOS and Android devices.

Note: See the compatibility tab on product pages for information on recommended Android devices. [MoveMic One](#), [MoveMic Two](#), [MoveMic Two Receiver Kit](#) and [MoveMic Receiver](#).

- Plug-and-Play Operation supporting landscape and portrait recording
- Innovative, Discrete MoveMic Design, hybrid mic and clip, can be affixed to a variety of materials with excellent sound quality and reliability
- Flexible Recording Control with the MOTIV™ Audio and Video Recording applications which include remote gain adjustment settings
- Support for 1 or 2 microphone recordings

Tip: Turn on Airplane Mode and Do Not Disturb to prevent interruptions to the recording caused by phone calls, text messages, or alerts.

The Shure MoveMic





Powering the MoveMic On and Off



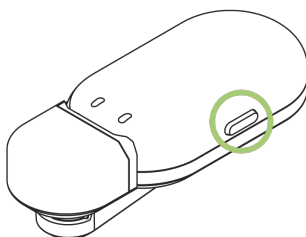

Power On: Press and hold the MoveMic power button for 3 seconds until both LEDs double flash. Continue to hold power button to put MoveMic into pairing mode.

Power Off: Press and hold the MoveMic power button for 3 seconds until the LED power indicator flashes red twice. Release the button. You can now put the MoveMic away.

MoveMic Button Commands



	MUTE/UNMUTE MIC	Press once	
	POWER ON	Hold for 3 seconds	

	POWER OFF	Hold for 3 seconds or place mic into Charge Case and shut the lid	
	PAIRING MODE	Hold 6 seconds from a powered-off state	

MoveMic LED Indicators

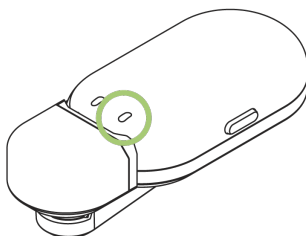

Power LED

MoveMic On	Green double flash
Muted	Red solid
MoveMic Off	Red double flash, then off

Note: No LEDs may also be an indication that LEDs have been toggled off in the MOTIV application.

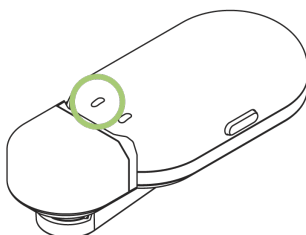

Connection LED

Pairing mode	Alternating red and blue
Successful Pair	Solid blue for 30 seconds
Low battery level	Red persistent flashing
Medium battery level	Solid amber for 30 seconds
High battery level	Solid green for 30 seconds
Unlocked	Green flashing
Locked	Amber flashing
Factory reset	Green and red triple flash

Error

Red persistent slow flashing

The MoveMic Charge Case

The MoveMic Charge Case is a combination storage and charging case that is compact enough to fit inside your pocket. The magnetic lid keeps it securely closed to store the mics safely. The LED indicators on the outside of the case allow you to check the case and MoveMic battery levels when the lid is closed and the mics are docked inside. The case uses a rechargeable battery and can be connected to a laptop with the included USB-C cable when it requires charging. You can also charge the case with a charging brick (not included).

Tip: Ensure that the mics are charged and ready for instant recording by always keeping them docked in the Charge Case with the lid closed when not in use.

Charge Case Status LED Indicators

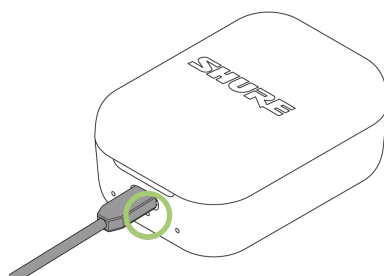

Charge Case status is the center LED.

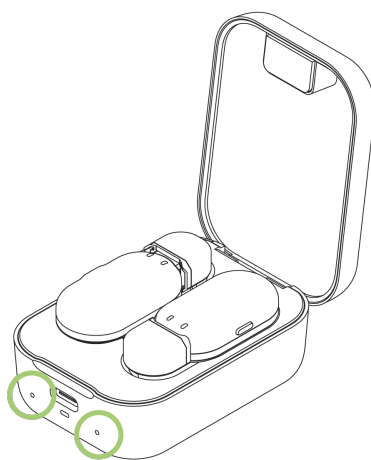

MoveMic status indicators are located under each mic.

Status	Color
Low battery	Red flash
Charging	Amber slow flash

Status	Color
Firmware update in progress	Green/Red alternating flash
Fully Charged	Green for 1 minute then off

The Charge Case will go into Sleep mode after 1 minute of inactivity. To wake the case, close the lid.

Important Tips for Care and Storage of Shure Rechargeable Batteries

Proper care and storage of Shure batteries results in reliable performance and ensures a long lifetime.

- Always store batteries and transmitters at room temperature
- Ideally, batteries should be charged to approximately 40% of capacity for long-term storage
- During storage, check batteries every 6 months and recharge to 40% of capacity as needed

Important: Always fully charge a new battery before first use, if possible.

The MOTIV Audio Application

Use the Shure® MOTIV Audio application to connect to microphones, adjust gain levels, and to record, edit and share audio. The device stores the most recently used settings for quick setup each time you record.

Tip: Turn on Airplane Mode and Do Not Disturb to prevent interruptions to the recording caused by phone calls, text messages, or alerts.

Pairing to the MOTIV app

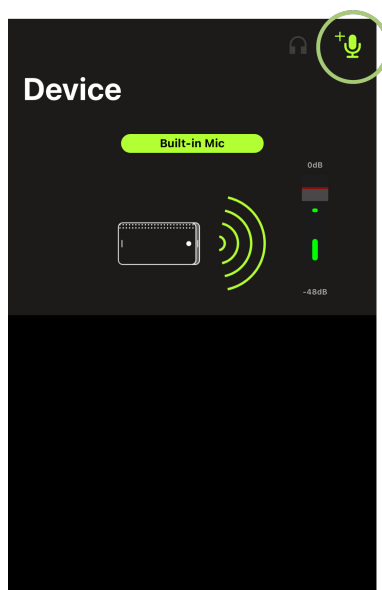

Circled icon is the Add Mic icon.

1. Open the MOTIV application and tap the Device icon.
2. Power on the MoveMic. Hold the Power On button long enough (6 seconds) to put the mic into pairing mode.
3. Ensure that your mobile device Bluetooth is on.
4. In the MOTIV app, tap the Add Mic icon. The mic will appear in the list of available microphones.

5. Tap an available microphone to Pair. Successful connection will be indicated by solid blue connection LED for 30 seconds, and the device settings screen will open.

Microphones that have been paired to MOTIV will automatically reconnect the next time MOTIV is opened.

Unpairing a Microphone

Connect up to 2 microphones at a time to the MOTIV app. If you'd like to use a different microphone and two mics are already connected, disconnect a microphone to make a space available for the new mic.

1. Tap the Add Mic icon to view all microphones that have been paired to the app.
2. Tap a connected mic for the option to stay connected or Disconnect and Forget.
3. When you disconnect a microphone, the channel is now available to pair to a second microphone.

Pairing a Second Microphone

To connect a second mic, just repeat the process.

1. Open the MOTIV application. First mic is already connected.
2. Power on and hold to turn on the second mic and put it into pairing mode.
3. Tap the Add Mic icon.
4. Select the mic you want to connect to.
5. Mic is paired. Use MOTIV to adjust mic gain and select video settings as needed.

If a previously paired mic becomes disconnected, MOTIV may indicate that the mic is out of range. The application will try to reconnect for up to 30 seconds. If needed, follow the steps listed above to manually reconnect.



Mic Settings

Use the MOTIV app to change microphone settings and to record, edit, and share audio. The device stores the most recently used settings for quick setup each time you record.

Tip: Turn on Airplane Mode and Do Not Disturb to prevent interruptions to the recording caused by phone calls, text messages, or alerts.

Preset Modes

Three selectable modes optimize settings for gain, equalization, and compression. Set the microphone level and try the modes to find which sounds best. Preset modes can affect the strength of the input signal, so adjust the microphone level as needed after changing presets.

Mode	Application	Characteristics
 Speech	speech	Equalization that emphasizes clarity and fullness, with gentle compression.
 Singing	solo or group vocal performances	Subtle equalization to add richness and clarity for a natural sound.

Mode	Application	Characteristics
 Flat	any	An unprocessed signal (no equalization or compression settings used). Adds flexibility when processing the audio after recording.

Custom Presets

Create and save custom presets to quickly access frequently used mic settings.

1. Start with the preset mode that best suits your application needs.
2. Adjust advanced settings, like compression, for clarity and consistency.
3. Tap Save to rename and save your new custom preset. The original preset will remain available.
4. The new custom preset is added to your list.

To access saved presets:

1. Tap the caret (arrow) in the Preset row to view your list of available presets.
2. Tap custom preset and Apply Preset to instantly apply gain, stereo, equalization, and compression preferences.

Tip: You can save a custom preset at any point. Tap Save and give the current settings a new name.

Advanced Mic Settings

After you have selected the preset mode for your application, fine tune the sound of your recording with limiter, compressor, and equalizer controls. Your settings will be retained in the microphone when using other audio and video recording applications.

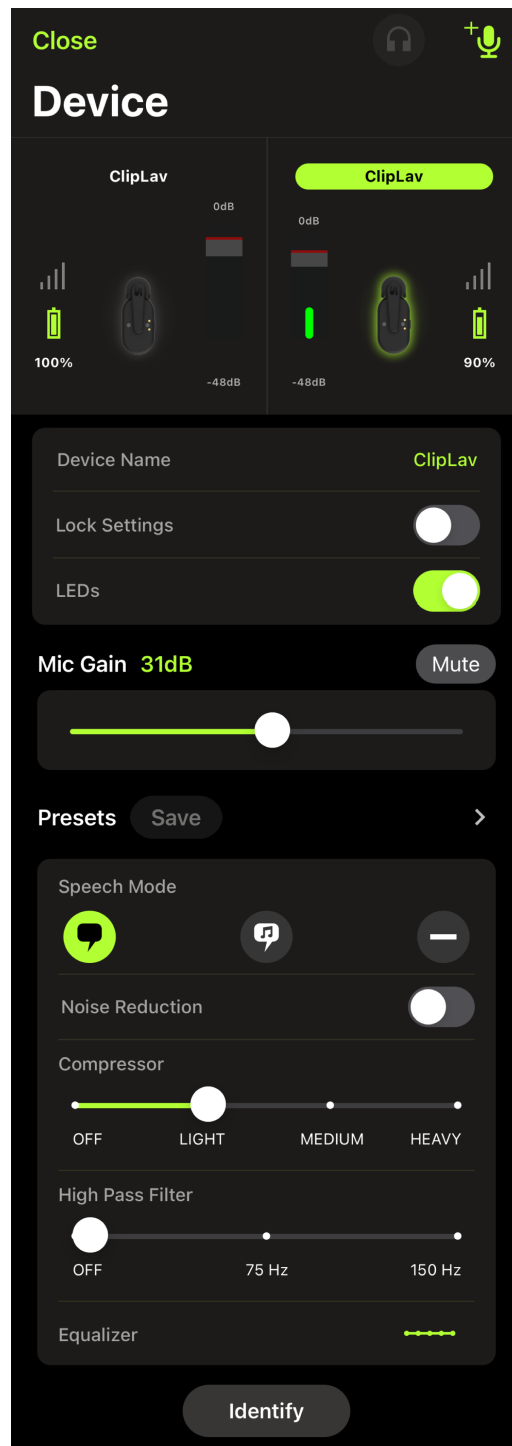

Device Name: Tap the Device Name if you'd like to customize your microphone name.

Lock Settings: Lock settings when you have dialed in your sound to ensure that nothing gets accidentally changed.

LEDs: Turn off the LEDs on the microphone transmitters for a more discrete mic presence.

Mic Gain: Use the mic gain slider to adjust the microphone input gain.

Mute: Press to mute and unmute the microphone.

Presets: Refer to the Presets and Custom Presets sections for more information on using presets and saving your own.

Noise Reduction: Significantly reduce the amount of noise in the signal caused by projectors, HVAC systems, or other environmental noise. It is a dynamic processor, which calculates the noise floor in the room and removes noise throughout the entire spectrum with maximum transparency. Use in rooms with controlled acoustics and minimal echoes for the most natural sound.

Compressor: Choose no compression, or select light or heavy compression to control volume when your sound source is dynamic. The compressor will narrow the dynamic range, which means that quiet signals are boosted and loud signals are lowered.

High Pass Filter: Choose no HPF for the most natural sound. Or select 75 Hz or 150 Hz to reduce wind noise, room noise, or proximity effect.

- **75 Hz Low frequency cutoff** Provides a 6 dB-per-octave cutoff at 75 Hz. Helps eliminate floor rumble and low-frequency room noise from heating and air conditioning systems. This setting may also be used to compensate for proximity effect or to reduce low frequencies that make an instrument sound dull or muddy.
- **150 Hz Low frequency rolloff** Provides a 6 dB-per-octave rolloff filter at 150 Hz. Use this to compensate for proximity effect or to reduce low frequencies that could make an instrument sound dull or muddy.

Equalizer: Change the preset modes to hear the DSP changes, and then use the equalizer to boost or cut bands of frequencies to improve sound clarity.

Identify: Select Identify in the receiver menu to quickly clear up confusion if you forget which microphone is one or two. The LED flashes for easy identification.

The MOTIV Video Application

The Shure MOTIV Video recording app provides instant video recording with uncompressed audio for your mobile device. Customize the sound with digital signal processing (DSP) preset modes, adjustable gain, and stereo width control.

Features

- Compatible with iOS, Android, PC and Mac devices.

Note: See <https://www.shure.com/en-US/motiv-compatibility> for information on recommended Android devices.

- Plug-and-Play Operation supporting landscape and portrait recording
- Flexible Recording Control includes gain adjustment settings
- Support for mono and stereo audio devices
- When used with MOTIV microphones, preset modes are available for a variety of recording situations.

Tip: Turn on Airplane Mode and Do Not Disturb to prevent interruptions to the recording caused by phone calls, text messages, or alerts.

Video Standby Mode

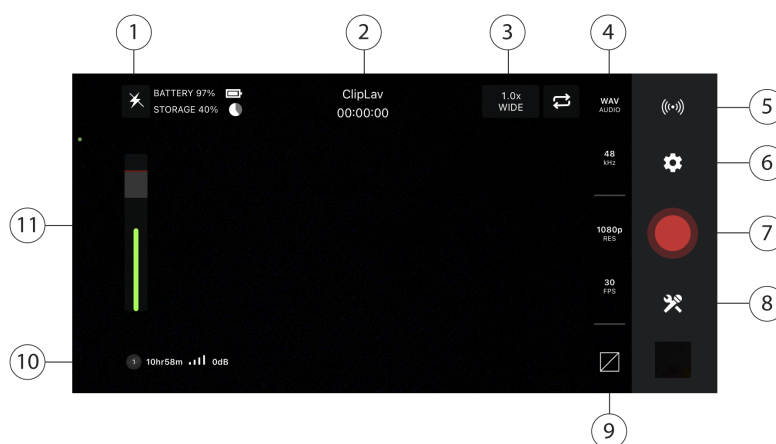

① **Flash** Use the flash when recording in low light situations.

② **Connected Device/Recording Length/Focus Lock** Device status will display the name of the connected MOTIV device. Recording length is displayed in hours, minutes, and seconds. See the Visual Settings topic for information on setting image focus and exposure.

③ **Zoom Level/Reverse Camera** Pinch the screen to adjust your zoom level for a closer view of your subject. Use the arrow circle icon to switch between front and back camera. Use the front-facing camera to shoot selfie videos.

④ **Audio/Video Quality Settings** Select your audio file type, sample rate, video frame rate and video resolution from a column of options.

Note: Option availability may vary based on your mobile device specifications.

- **Audio file type:** WAV, ALAC, AAC
- **Sample rate:** 44.1 kHz, 48 kHz
- **Video resolution:** 720p, 1080p, 4K
- **Frame rate:** 24 fps, 30 fps, 60 fps

⑤ **Livestream** Tap to access live stream options. See the Livestream topic for information on livestreaming options.

⑥ **Settings** Tap the application settings sprocket icon to select audio and video quality, face detection, light or dark theme appearance, to find version information, help materials, and to send feedback.

⑦ **Record/Stop Button**

⑧ **Device Settings** Tap to access the Device settings screen and pair microphones to the app.

⑨ **Grid/Level/Off Display** Tap through to display grid lines or a level for easy image composition. Or turn this feature off if you prefer a clean display.

⑩ **Battery Life/Storage Space** Displays percentage of remaining battery life and available storage space for your recording device.

⑪ **Input Meter/Microphone Gain** Displays the strength of the input signal. Tap the input meter to bring up the mic gain and direct monitoring sliders. You can adjust microphone gain during recording to match the volume of the sound source. Make live adjustments to ensure levels are in the target range (indicated by the shaded region of the input meter).

Visual Settings

Be sure to adjust your visual settings to get the best-looking video image. We recommend making adjustments in this order.

Zoom: Pinch to zoom in or out and frame your shot.

Brightness: Swipe up and down to set brightness level.



Focus: Tap to focus or tap and hold to lock brightness and focus. Tap again to release the lock.



Mic Gain Sliders

Access the mic gain sliders when you want to quickly adjust your volume. Tap the input meter to open the mic gain window. Use the sliders to determine how much of each input you hear. When you are finished adjusting the volume, tap outside the mic gain slider window to return to the standby or record view.

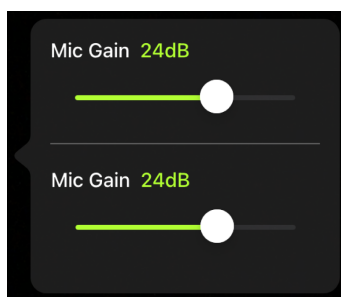

The top slider adjusts gain for first mic and the bottom slider adjusts mic gain for the second.

Video Record Mode

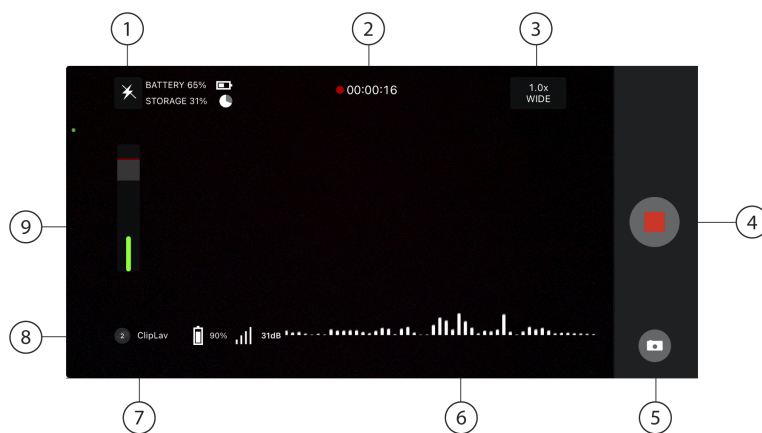

① **Flash** Use the flash when recording in low light situations.

② **Connected Device Status/Recording Length/Focus Lock** Status will display the model name of the connected MOTIV device. Recording length is displayed in hours, minutes, and seconds. The red dot will flash when video is recording. See the Visual Settings topic for more information on focus and exposure.

③ **Zoom Level** Pinch the screen to adjust your zoom level for a closer view of your subject.

④ **Record/Stop Button** Start and stop video recording.

Note: Video files are saved to the Photos application on your mobile device.

- ⑤ **Camera** Take a snapshot while video is recording.
- ⑥ **Audio Recording** The MOTIV Video recording application displays the audio waveform as it is being recorded.
- ⑦ **Grid** Use the grid lines to assist in composing your image.
- ⑧ **Battery Life/Storage Space** Displays percentage of remaining battery life and available storage space for your recording device.
- ⑨ **Input Meter** Displays the strength of the input signal. Tap the input meter to bring up the mic gain and direct monitoring sliders. You can adjust microphone gain during recording to match the volume of the sound source. Make live adjustments to ensure levels are in the target range (indicated by the shaded region of the input meter).

Compressed Format Recording

The MOTIV app records uncompressed audio files to provide the highest quality recording. However, you might find it more useful to record in a compressed file format. Compressed files take up less storage space allowing you more space on your device to record. It's also easier to share compressed files by message or email because compressed files use less data. Consider using a compressed format for recording demos or initial ideas because in this case it is more important to capture the idea than have the highest possible fidelity recording.

If you are unsure about which format to choose, start with the highest quality setting. You can always compress files later from your library if you find that you require smaller file sizes. See the Supported Audio Formats section to learn about the file formats that are available to you.

Remember: You can convert compressed audio to an uncompressed format, uncompressed audio to a compressed format and one type of compressed format to another. However, only WAV files can be edited. If you need to edit a file, convert the file to a WAV file first.

Live Streaming

Live Stream Using the MOTIV Video App

You can use the Shure MOTIV Video app to connect with Facebook or YouTube and live stream while using the MoveMic One and MoveMic Two with direct to phone connectivity. This allows you to capture and adjust professional quality audio as you stream to your live video feed.

Record a Test Run

Most streaming services provide the ability to do a unlisted test stream to a limited or private audience. Take advantage of this opportunity to test out your equipment and determine what settings sound best before you go live.

1. Start the MOTIV Video app. Ensure that you are using the latest version of the app.
2. Configure Audio/Video settings before you start to live stream.
3. Connect 2 ClipLavs for stereo or 1 ClipLav for mono recording. Once recording starts you cannot change between stereo or mono audio without stopping the live stream.
4. Adjust audio settings, like compression, for clarity and consistency.
5. During live stream session, audio input monitoring and audio direct monitoring are available with same behaviors as video record mode.
6. Tap Save to rename your live stream preset, or use the default name. The custom preset will be added to your list of presets.

Use the MOTIV app to live stream or to record videos. The app does not support simultaneous live streaming and video recording to the device.

Tip: Monitor with earphones to listen to playback without introducing echo.

Easy Live Streaming to Facebook and More

Stream to Facebook

1. Open the MOTIV Video app.
2. Pair the ClipLavs.
3. Tap the Livestream icon and select Facebook Live. The Facebook login will open.
4. Before you begin, add title and description. Select audience, where to post (timeline, page or group), stream bitrate and video quality.
5. Tap Go Live. The countdown to your live stream will begin and you will be live. Begin the broadcast.
6. End the broadcast from the MOTIV app by tapping the red Stop Record button.

Stream to YouTube

1. Open the MOTIV Video app.
2. Pair the ClipLavs.
3. Tap the Livestream icon and select YouTube. The YouTube login will open.
4. Log in to your YouTube account. Note: If the YouTube channel has less than 50 subscribers, you will be asked to use a RTMP/RTMPS connection to stream.
5. Before you begin, add title and description. Select visibility (public or unlisted), stream bitrate and video quality.
6. Tap Go Live. The countdown to your live stream will begin and you will be notified that the live stream is live. Begin the broadcast.
7. If you have prescheduled a live stream, you can select that stream option or choose to start a new stream from the app.
8. End the broadcast from the MOTIV app by tapping End Livestream.

While You Stream

1. You can monitor comments and likes from your viewers as they come in from within the MOTIV app.
2. View livestream viewer count to know how many viewers are watching.

If you are interested in starting a stream from another platform, log out of the first account from the MOTIV app. This way you will be free to log into another account. You cannot stream to more than one account at a time.

Hardware Receiver

The MoveMic Receiver

The MoveMic Two Receiver Kit expands recording options by adding a hardware receiver to the MoveMic kit. The receiver packs mic settings features into a palm-sized, portable package with incredible audio clarity, long-range transmission and easy to use features. Connect the receiver to your phone or camera, easily mounted using the cold shoe mount. Download the MOTIV Video app for a complete portable content creation kit.

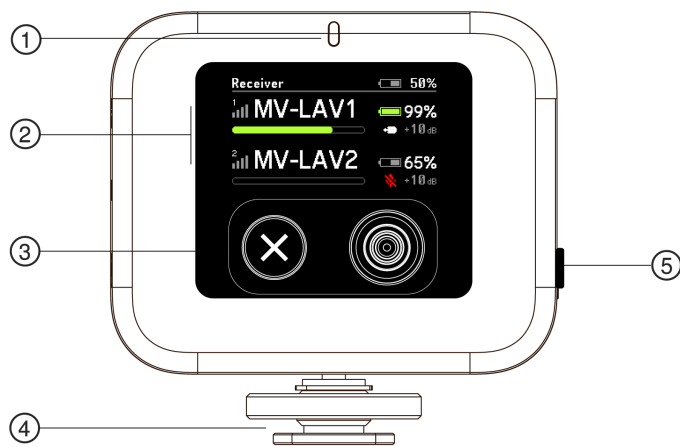

Front Panel

① **LED status indicators** Displays receiver information related to mic connection, battery and charge levels. See MoveMic Receiver LED Indicators topic for indicator status information.

② **Channel 1 / Channel 2 status** Displays connection status, mic name, battery time percentage and audio gain levels. See Receiver Setup topic for more information.

③ **Navigation buttons** Use the left X button to cancel. Press the right button to enter or select a choice when navigating the receiver menu. Right button is also a directional toggle.

④ **Cold shoe mount** Use the cold shoe mount to secure the receiver to a camera or camera accessory.

⑤ **Power button** Press and hold to power the receiver on and off.

MoveMic Receiver LED Indicators

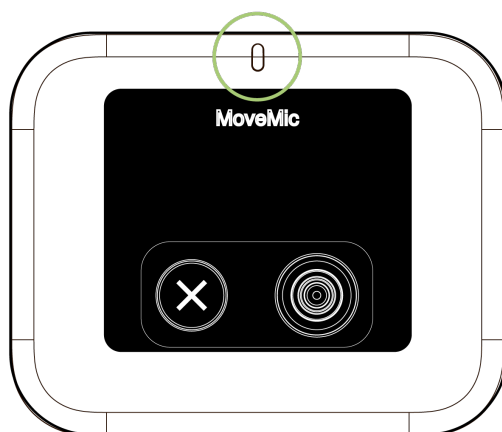

LED Indicator

Status	Color
Seeking connection with mic	Blue flashing
Connected	Solid blue
Low battery level	Red persistent flashing

Status	Color
Charging in process	Amber flashing
Error	Red persistent slow flashing
Fully charged	Solid green for 60 seconds, then off

Adjusting the Receiver

The receiver has a hinge and can be rotated 90 degrees horizontally or vertically to keep it securely out of the way when recording.

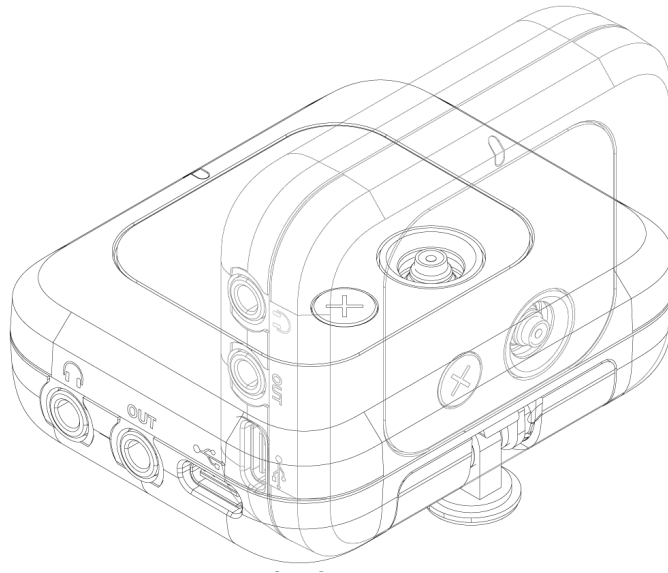

Adjusting Receiver Position

Connecting to the Receiver

Connecting to the Camera

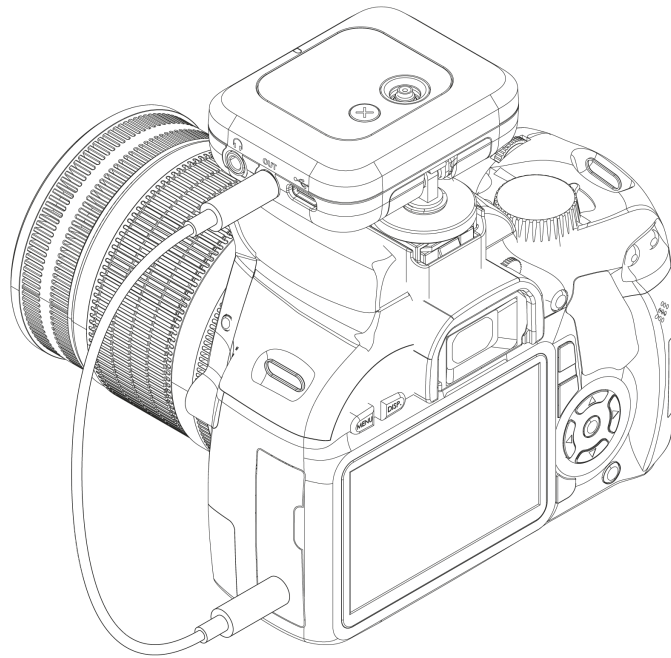

Mount the MoveMic receiver onto the cold shoe on top of your camera. Use the supplied 3.5mm to 3.5mm cable to connect the receiver to your camera.

Connecting to the Phone

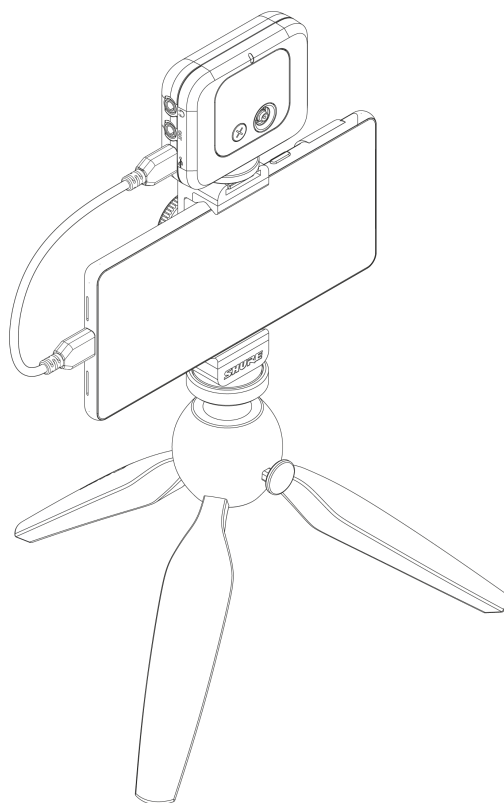

Use the supplied USB-C to USB-C cable to connect the MoveMic receiver to your phone or computer for additional compatibility to third party apps.

Pairing to the Receiver

Important: Ensure that the MoveMics and receiver are fully charged before the first use.

1. Remove microphones from charge case and put in pairing mode. (Hold button for 6 seconds until blue light flashes).
2. On the receiver, navigate to the My Devices menu. Select Connect New Mic.
3. Select an available microphone in the Searching for mics menu to Pair.

Microphones that have been previously paired will automatically reconnect the next time they are used.

The Receiver Display

Use the MoveMic Receiver to rename microphones, review microphone and battery status and connect to a variety of input sources.

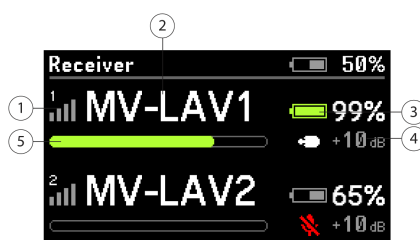

- ① **Mic Connection Strength** Displays connection levels between the mic and the receiver.
- ② **Microphone Name** Displays name to identifying microphones.
- ③ **Mic Battery Level** Displays icon and percentage of battery strength.
- ④ **Microphone Status** Displays microphone type and gain information.
- ⑤ **Microphone Level Meter** displays audio signal level and peaks.

The Receiver Menu Tree

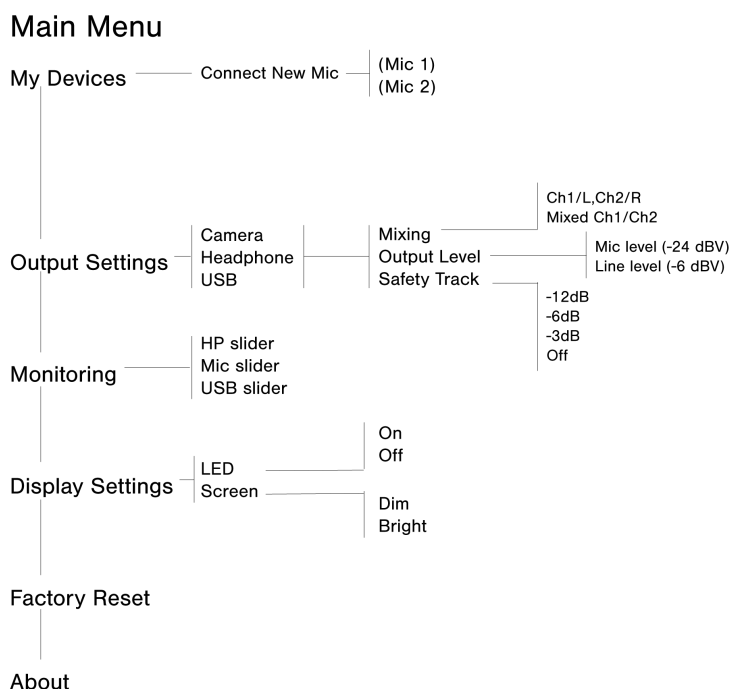

My Devices

- **"Mic Name"**: Displays the name of connected mic. You can rename each mic for easy identification.
- **Gain/Mute**: Adjust the gain for each microphone so the loudest sounds peak at about 75% of the meter for best quality sound.
- **Audio Effects**: Your audio settings to dial in the optimal sound.
- **LED**: Turn the transmitter LED off or on.
- **Identify**: Select Identify in the receiver menu to quickly clear up confusion if you forget which microphone is one or two. The LED flashes on the transmitter for easy identification.
- **Mode**: Use Presets to quickly optimize settings for your application.

Output Settings

- **Safety Track**: The Safety Track is a secondary recording to ensure that you'll have a backup file in case anything should happen to your audio. You can set the gain for the safety track here.

Monitoring

Display Settings

- **LED**: Turn the transmitter LED off or on.
- **Screen**: Adjust the brightness of the receiver screen

Factory Reset: When the receiver malfunctions use Factory Reset to completely reset the device to factory settings.

About: The About screen shows you the versions of software and firmware update that you have. When speaking to customer support you might be asked to provide this information.

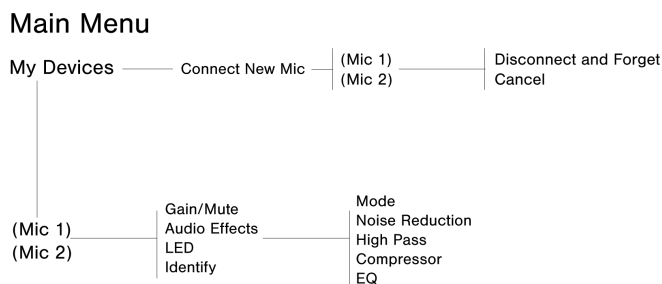

When mic is paired it moves to the top level of the menu tree for quick mic adjustment.

Recording Tips

Turn On Airplane Mode and Do Not Disturb

When you connect your microphones to your mobile device, be sure to enable Airplane Mode and Do Not Disturb. It's important to do this to avoid recording interference from phone calls, messages, and various notifications.

Note: Leave Airplane Mode off to add geolocation information to your audio file.

Capture Clear Sound

For best signal-to-noise ratio when using the MoveMic receiver start with the output level set to Line level and lower the volume on your camera. Then raise the volume until you get the strongest signal without peaking. If that doesn't work, switch output level to Mic level.

Use the Dark Theme

Select the Dark screen option to change the device application display from light gray to very dark gray. The darker display is ideal for discreet recording in low-light situations. A darker screen also conserves battery life.

You can access the theme appearance setting by going to **Settings > Appearance**

Monitor Your Sound

We recommend that you use a wired connection to monitor your recordings. When using the MoveMics, first plug-in your wired headphones and then pair the MoveMics to the app. Monitoring your recording while using a Bluetooth headset is not currently supported. The receiver has a headphone output which allows you to monitor directly from the receiver. Monitoring while recording allows you to make volume adjustments as needed for the highest quality recording.

Note: Use phone buttons to adjust monitoring volume.

Gallery

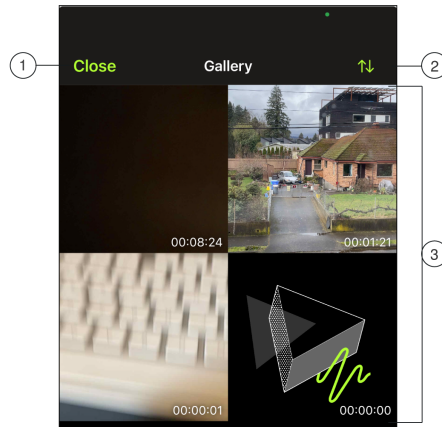

An example of the gallery in grid view.

① **Close:** Tap Close to exit out of the video gallery.

② **Gallery View/Sort:** Use the drop-down menu to choose your gallery and sort views.

- List view displays file details. Grid view displays thumbnail and file length. Card view displays scrollable full screen images with file information.
- Sort displays videos by date or size.

③ **Track List:** Displays your collection of recorded videos.

Note: iOS users have the ability to search for files in the MOTIV Library by using the Spotlight feature.

Video Playback

Tap the video in the gallery to access the Playback window.



The Video Playback window displays

- **Track Information:** Audio and video formats, bit depth, and sample rate.
- **Track Artwork:** A representative thumbnail.
- **File information:** The recording date and time.
- **Timeline:** See where you are in the track as it progresses. The time elapsed and time remaining are displayed around the timeline.
- **Share, Playback, Delete:** Share your video. Rewind, Play/Pause and Fast-forward or permanently delete your video.

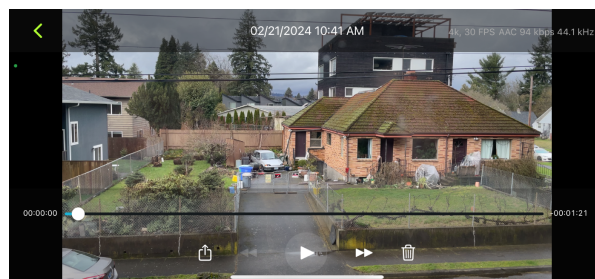

Sharing Video Recordings

Save to Camera Roll

Convert your audio into a video file that can be easily shared to social media from your device photo application (Camera Roll or Photos).

1. Open the MOTIV application and go to the Library.
2. Tap to highlight the file you want to share or convert.
3. Tap the three dots to reveal file options.
4. Select the Share button.
5. Select Save to Camera Roll.
6. You have the option to save a thumbnail or use a MOTIV image.
7. The conversion will happen automatically. Large files will take longer to convert.

Note: The first time you save to Camera Roll you will be asked to grant permission for file sharing between applications. If you accidentally dismiss permissions, you can always change access in the device settings. Granting permission creates a MOTIV folder inside the photo app.

8. When the conversion process is complete, you will receive a success notification to let you know that your track is available for sharing.

Save to Dropbox™

Save your MOTIV files to Dropbox to store backup copies, free up space on your iOS device, or share to social media.

1. Open the MOTIV application and go to the Library.
2. Tap to highlight the file you want to share.
3. Tap the three dots to reveal file options.
4. Select Share, select More, select Dropbox.

Note: You may need to grant access between MOTIV and Dropbox. Selecting "Allow" creates a MOTIV folder inside Dropbox and links the applications.

5. When the file successfully uploads, the file saved notification appears.

Note: Large files may take longer to upload.

Now that your file is uploaded to Dropbox, you can store backup copies of your recordings or share them on social media.

AirDrop® with MOTIV

MOTIV supports the ability to AirDrop WAV files to selected contacts.

1. Open the MOTIV application and go to the Library.
2. Tap to highlight the file you want to share.
3. Tap the three dots to reveal file options.
4. Select Share, select More, select AirDrop to view your AirDrop contacts.

MoveMic Firmware Updates

Firmware is embedded software in each component that controls functionality. Periodically, new versions of firmware are developed to incorporate additional features and enhancements. To take advantage of design improvements, download new versions of the firmware when prompted by the app.

Charge Case Update Tip: For best results, before updating make sure that the MoveMics are docked inside the charge case and fully charged. Connect the charge case to your device using the correct Lightning or USB cable. The charge case flashes amber to indicate that the firmware update is in progress.

If you run into problems updating the firmware, new versions of the firmware can be uploaded and installed using the [Shure Update Utility](#).

Troubleshooting

Issue	Solution
Mic no longer paired to MOTIV	<p>Mic may unpair if it sits idle and is not being used, is placed back into the case or if the phone enters sleep mode. Close and reopen the app. The microphones will automatically attempt to re-pair.</p> <p>Tap the Add Mic icon to re-pair. You'll know that the connection is secure when the microphone name is visible in the status bar.</p> <p>If you are still experiencing pairing issues, tap the microphone icon and select Forget. Then follow pairing instructions with this clean start.</p>
Microphone is paired, but the audio meter does not register a signal.	<p>Edit the privacy setting for your recording device under SETTINGS > PRIVACY > MICROPHONE to give MOTIV permission to use the microphone.</p>
Audio sounds bad or distant	<p>To ensure that you are receiving audio from the MoveMic and not a built-in microphone, confirm that the MoveMic is connected. You'll know that the connection is secure when the microphone name is visible in the app.</p> <p>If you are using the hardware receiver, ensure that your cable connections are secure.</p>
Audio is distorted	<p>Use the audio meter to ensure that volume peaks are within the target range (the gray area). If the level reaches the red peak indicator of the input meter, tap the input meter to access mic gain and turn the gain down with the slider.</p>
Audio is not in sync with video	<p>Switch to a lower frame rate or resolution size. You might achieve better performance with a less system intensive frame rate.</p>
Recording stops due to overheating	<p>MOTIV Video recording application responds to device overheating by disabling the meter and waveform display. If device continues to overheat, MOTIV will save your recording and shut down. Ensure that your device has cooled down before starting a new recording.</p>
Unable to share file	<p>If a file is too large to be shared, there are a couple options for reducing file size.</p> <p>Convert your file to a compressed file format.</p> <p>Connect your mobile device to your computer and use file transfer, like iTunes, to download the file to your desktop.</p> <p>Split your track in two, export both files and recombine them using audio editing software.</p>
General troubleshooting	<p>Ensure that the microphones and device are all charged.</p> <p>Ensure that MOTIV is updated to the most current version.</p> <p>Make sure that your phone's operating system is updated to the most current version.</p>

Issue	Solution
	<p>Check to see how the microphone works using a different device. Close and restart the application. Powering down and rebooting the device will clear the cache and can sometimes help with software performance.</p>
<p>Factory Reset</p>	<p>In the event that the MoveMics, charge case, receiver or app become unresponsive, it may be necessary to perform a factory reset to restore the item to factory settings.</p> <p>MoveMic: Perform a factory reset by toggling the MoveMic button off. Then press the power button quickly 2 times, press and hold for 10 seconds or longer on the third press to reset. MoveMic will triple flash green and red during the reset.</p> <p>Charge Case: The inside of the case has a pin hole reset.</p> <p>Receiver: Factory Reset can be found near the bottom of the hardware receiver menu.</p> <p>MOTIV app: Close and restart the application.</p>

System Requirements

System Requirements and Compatibility: iOS

- **iOS:** iOS 15 and higher
- **iPhone:** iPhone 12 and higher
- **iPad:** iPad Pro (USB-C)

System Requirements and Compatibility: Android

Will work with any Android device that has:

- Android 12.0 (Snow Cone) and higher
- USB Audio Class 2.0 support and higher
- Bluetooth 5.0 and higher

Android is a trademark of Google Inc.

Note: See the compatibility tab on product pages for information on recommended Android devices. [MoveMic One](#), [MoveMic Two](#), [MoveMic Two Receiver Kit](#) and [MoveMic Receiver](#).

Accessories

Furnished Accessories

MV-ONE

- 1 MoveMic Lav
- 1 foam windscreen
- AMV-USBC-USBC15: 1 USB-C to USB-C cable, 15"
- 1 Charge Case

MV-TWO

- 2 MoveMic Lavs
- 2 foam windscreens
- AMV-USBC-USBC15: 1 USB-C to USB-C cable, 15"
- 1 Charge Case

MV-TWO-KIT

- 1 MV-R
- 2 MoveMic Lavs
- 2 foam windscreens
- AMV-USBC-USBC15: 1 USB-C to USB-C cable, 15"
- 1 Charge Case
- 1 Roll bag

Optional Accessories

- AMV-USBC-LTG15: 1 USB-C to Lightning cable, 15"

Specifications

The MoveMic

Frequency Response

50 Hz to 20 kHz

Dynamic Range

100 dB, A-weighted

Signal-to-Noise Ratio

68 dB SPL, A-weighted

Equivalent Input Noise

26 dB SPL, A-weighted

Maximum SPL

130 dB SPL

Nominal Voltage

3.7 V DC

Sensitivity (with MV-LAV)

-37 dBFS @94 dB SPL (1 Pascal RMS)

Bit Depth

24-bit

Sampling Rate

48 kHz

Gain Adjustment Range

0 to 60 dB

Range

Up to 100 ft (30m) line of sight

Radio Frequency Range

2400 MHz to 2483.5 MHz

Technology

Bluetooth Low Energy and Proprietary

RF Output Power

SR7XW	+16 dBm
SR6XW	+9.66 dBm

Dimensions

1.81 in. x 0.87 in. x 0.59 in. (46 mm x 22 mm x 15 mm)

Net Weight (no windscreen)

0.29 oz. (8.2g)

Housing

Black PC/ABS Thermoplastic

Water Resistance

IPX4

Battery Type

Rechargeable Li-Ion Coin Cell

Battery Runtime (Direct to Phone)

Normal Power:	Up to 11.3 hours
High Power [1]:	Up to 8.7 hours

Antenna

Sheet metal with copper-nickel-zinc alloy

[1] High Power is applicable in the Americas and isn't available in all regions.

Supported Audio Formats**Android**

PCM/WAV	Up to 352 KHz
----------------	---------------

AAC	256, 128, 96
------------	--------------

iOS

PCM/WAV	Up to 352 KHz
MP4 Audio	Audio files: .mp4, .m4a, .m4p, .m4b
AAC	256, 128, 96
ALAC	Audio file: Apple Lossless

The MoveMic Charge Case

MFi Certified

Yes

Dimensions

2.93 in. x 2.10 in. x 1.31 in. (74.5mm x 53.3mm x 33.2mm)

Net Weight

80.3g (2.83 oz)

Housing

Black PC/ABS Thermoplastic

Battery Type

Rechargeable Li-Ion Battery Pack

Nominal Voltage

3.7 V DC

Battery Operating Temperature

2 to 35 °C (35.6 to 95 °F) [1]

Battery Charge Time

2.5 Hours

USB Host Power Requirement

≥100 mA

[1] Charge rates are slower at colder temperatures (2 to 15 °C (35.6 to 59 °F))

The MoveMic Receiver

MFi Certified

Yes

Frequency Response

50 Hz to 20,000 Hz

Dynamic Range

100 dB, A-weighted

Signal-to-Noise Ratio

68 dB SPL, A-weighted

Equivalent Input Noise

26 dB SPL, A-weighted

Maximum SPL

130 dB SPL

Sensitivity (with MV-LAV)

-37 dBFS @94 dB SPL (1 Pascal RMS)

Bit Depth

24-bit

Sampling Rate

48 kHz

Gain Adjustment Range

0 to 60 dB

Minimum Load Impedance (Headphone)16 Ω **Maximum Headphone Output Level**

26.4mW @ 1% THD

Minimum Load Impedance (Camera Out)2k Ω **Maximum Camera Output Level (Mic)**

-26dBV

Maximum Camera Output Level (Line)

-8.3dBV

Range

Up to 100 ft (30m) line of sight

Radio Frequency Range

2400 MHz to 2483.5 MHz

RF Output Power

SR7XW	+16 dBm
--------------	---------

SR6XW	+9.66 dBm
--------------	-----------

Dimensions

52.8 x 67 x 19 mm (2 x 2.64 x 0.75 in.), H x W x D

Weight

81 g (2.86 oz.)

Housing

Black PC/ABS

Antenna

Sheet metal (tin-plated steel)

Battery Type

Rechargeable Li-Ion Battery Pack

Battery Runtime (MoveMic to MV-R Receiver)

Normal Power:	Up to 8 hours
High Power [1]:	Up to 7 hours

Battery Runtime (MV-R Receiver)

Normal Power:	Up to 8 hours
High Power [1]:	Up to 7 hours

[1] High Power is applicable in the Americas and isn't available in all regions.

Open Source Attribution

<https://content-files.shure.com/attributions/move-mic-attributions.pdf>

Certifications

Meets essential requirements of the following European Directives:

- WEEE Directive 2012/19/EU, as amended by 2008/34/EC
- RoHS Directive EU 2015/863

Note: Please follow your regional recycling scheme for batteries and electronic waste

CE Notice

Hereby, Shure Incorporated declares that this product with CE Marking has been determined to be in compliance with European Union requirements.

The full text of the EU declaration of conformity is available at the following site: <https://www.shure.com/en-EU/support/declarations-of-conformity>.

UKCA Notice

Hereby, Shure Incorporated declares that this product with UKCA Marking has been determined to be in compliance with UK-CA requirements.

The full text of the UK declaration of conformity is available at the following site: <https://www.shure.com/en-GB/support/declarations-of-conformity>.

本产品不支持快充，消费者若使用电源适配器供电，则应购买配套使用获得CCC认证并满足标准要求电源适配器

Aviso de ANATEL:

Modelo Regulatório: SC7LW

"Este equipamento não tem direito à proteção contra interferência prejudicial e não pode causar interferência em sistemas devidamente autorizados"

Este produto está homologado pela Anatel de acordo com os procedimentos regulamentados para avaliação da conformidade de produtos para telecomunicações e atende aos requisitos técnicos aplicados, incluindo os limites da Taxa de Absorção Específica referente a campos elétricos, magnéticos e eletromagnéticos de radiofrequência.

Valores de SAR medidos

Corpo: 0,288 W/Kg, à distância de 0mm - Tecnologia Bluetooth Low Energy PHY 1M

Cabeça: 0,415 W/Kg, à distância de 0mm - Tecnologia Bluetooth Low Energy PHY 1M



Made for iPad (5th generation), iPad (6th generation), iPad (7th generation), iPad (8th generation), iPad Air 2, iPad Air 3, iPad Mini 4, iPad Mini 5, iPad Pro 9.7-inch (1st generation), iPad Pro (12.9-inch) 1st generation, iPad Pro 10.5-inch 2017 (2nd generation), iPad Pro 12.9-inch 2017 (2nd generation), iPhone 6s, iPhone 6s Plus, iPhone SE, iPhone 7, iPhone 7 Plus, iPhone 8, iPhone 8 Plus, iPhone X, iPhone Xs, iPhone Xs Max, iPhone XR, iPhone 11, iPhone 11 Pro, iPhone 11 Pro Max, iPhone 12, iPhone 12 Mini, iPhone 12 Pro, iPhone 12 Pro Max, iPhone SE 2, iPod Touch (7th generation).

iPad, iPhone, iPod and iPod touch are trademarks of Apple Inc., registered in the U.S. and other countries. iPad Air, iPad mini, and Lightning are trademarks of Apple Inc. The trademark "iPhone" is used in Japan with a license from Aiphone K.K.